

# Assemble Instruction(Instructions d'assemblage)

Vendor:069C BECK F,Q,HB FB  
Fabricant : 069C SKU# BECK GF,Q,HB FR

ITEM.: 22014-F,Q

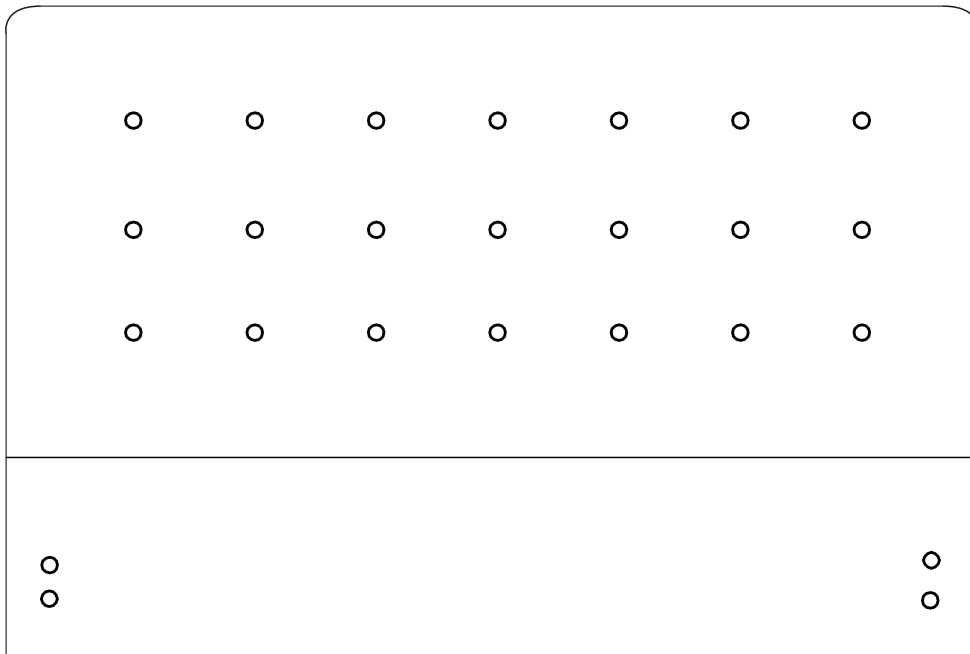





## PARTS LIST/Liste des pièces



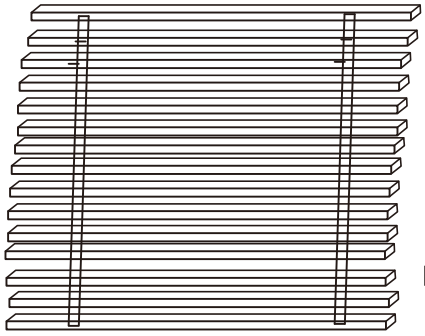

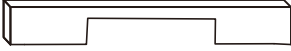



**A HEADBOARD**  
**/Tête de lit**

**1PC**

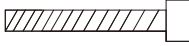
# Assemble Instruction(Instructions d'assemblage)

PARTS LIST/Liste des pièces					
	<b>E</b>	<b>E</b> SIDERAIL /Longerons latéraux	<b>2PCS</b>		<b>I</b>
	<b>F</b>	<b>F</b> Center rail /longeron central	<b>1PCS</b>		<b>L</b>
	<b>H</b>	<b>H</b> FOOTBOARD /Pied de lit	<b>1PCS</b>		
	<b>B</b>	<b>B</b> Small drawer /Le petit tiroir	<b>2PCS</b>		
	<b>D</b>	<b>D</b> Large drawer /Grand tiroir	<b>1PCS</b>		
	<b>K</b>	<b>K</b> support leg /support en métal	<b>2PCS</b>		
	<b>G</b>	<b>G</b> pulley /Poulie	<b>13PCS</b>		
		<b>L</b> Feet /Pieds	<b>4 PCS</b>		

## HARDWARE PACKED LIST IN BOX

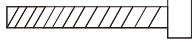
	<b>a</b> ALLEN KEY /Clé Allen 5/16"	<b>1PCS</b>		<b>b</b> Bolt /Boulon ø5/16"*1-1/2"	<b>12PCS</b>		Wrench /Clé plate ouverte	Not provided		<b>d</b> Flat Washer /rondelle plate ø5/16"	<b>16PCS</b>
	<b>e</b> Spring Washer /Rondelle en plastique ø5/16"	<b>16PCS</b>		<b>f</b> Nut/Écrou ø5/16"	<b>4PCS</b>		<b>g</b> SCREW/Vis	<b>20PCS</b>		<b>h</b> Bolt /Boulon ø5/16"* 2"	<b>4PCS</b>

### Step 1/Étape 1

Place washers( L ) through bolt (A) and fasten to bottom of footboard (H).  
/Insérer les rondelles ( L ) dans les boulons(A) et visser les pieds de lit par le dessous

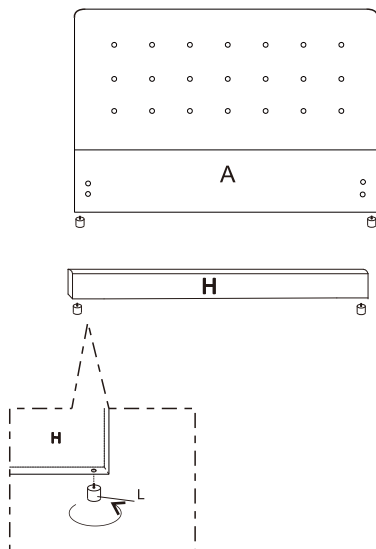

### Step 2/Étape 2

Bolts to use for side rails, should already come pre-inserted on the Headboard and Footboard /Les boulons destinés aux longerons latéraux doivent être déjà pré-insérés dans la tête de lit ainsi que le pied de lit

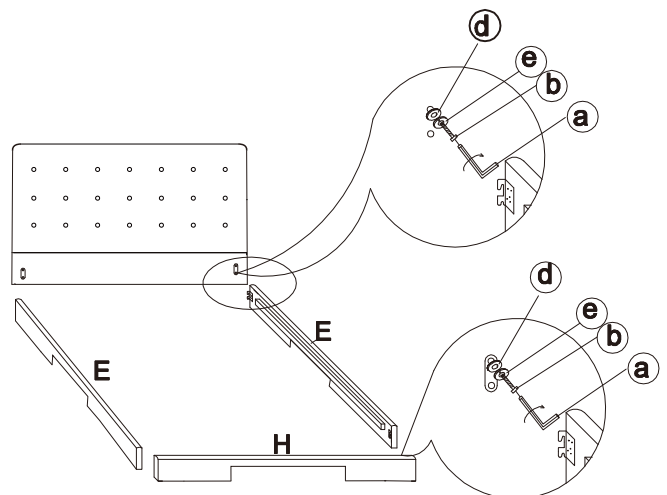

### Step 3/Étape3

Attach siderail (E) to headboard (A) and footboard (H) using bolt ( b ) and allen key ( a ) as shown in diagram. Do not tighten bolts completely until assembly is completed.

/Attacher les longerons latéraux(E) dans la tête de lit (A) ainsi que le pied de lit (H) à l'aide des boulons (b) et d'une clé Allen (a) tel que montré sur le schéma. Ne pas serrer à fond les boulons jusqu' à ce que l'assemblage soit complètement terminé

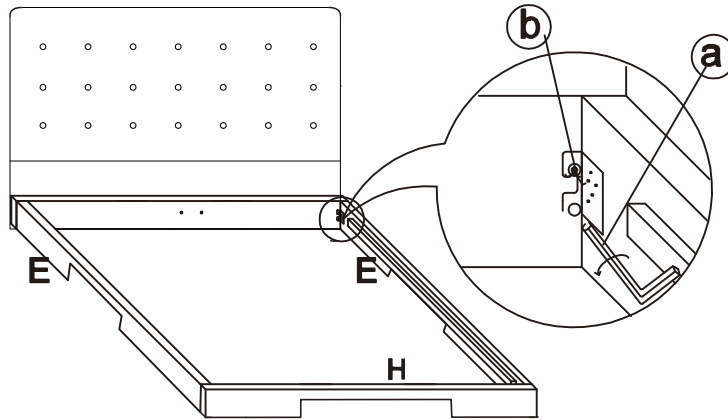

### Step 4/Étape4

Attach center support (F) to headboard (A) by using bolt ( b ) through washers( e , d ) as shown in diagram. Attach leg support (K) to center support bar (F) by using bolt ( h ), washers( e , d ), nut ( f ), and tighten the nut( f ) by wrench.

/Attacher le support central(F) dans la tête de lit (A) à l'aide des boulons (b) à travers les rondelles(e,d) . écou(f) et visser les écrous(f) à l'aide de la clé Allen

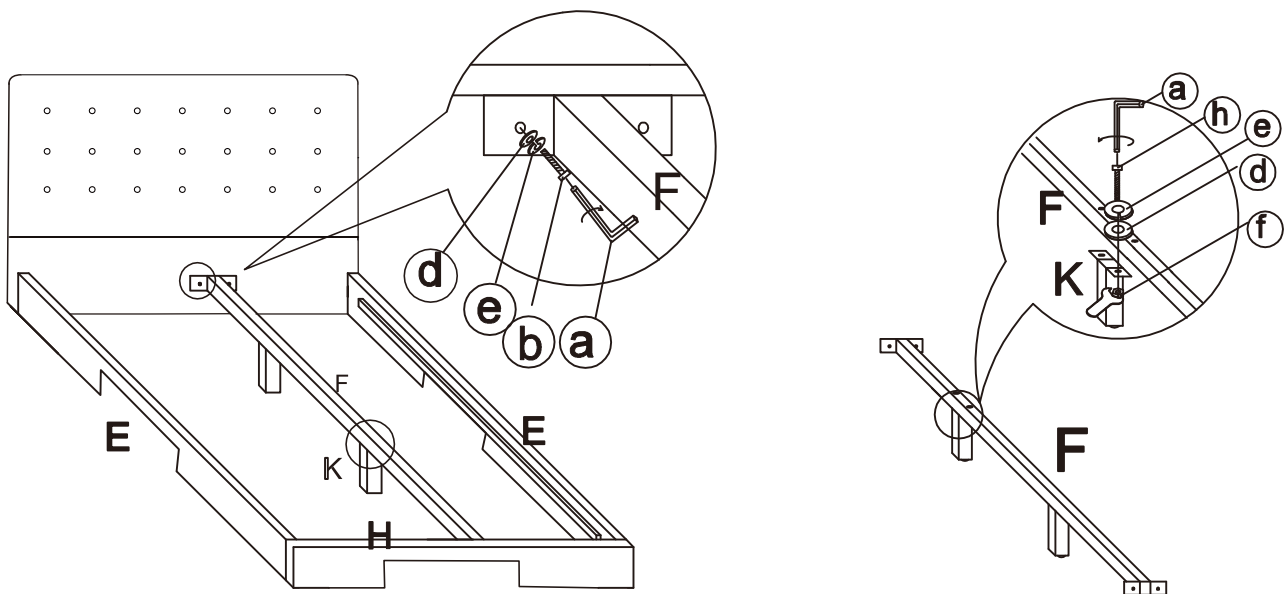

### Step 5/Étape 5

Insert slats ( I ) into bed as shown in diagram.

/Insérer les lattes ( I ) dans le lit tel qu'indiquer sur le schéma.

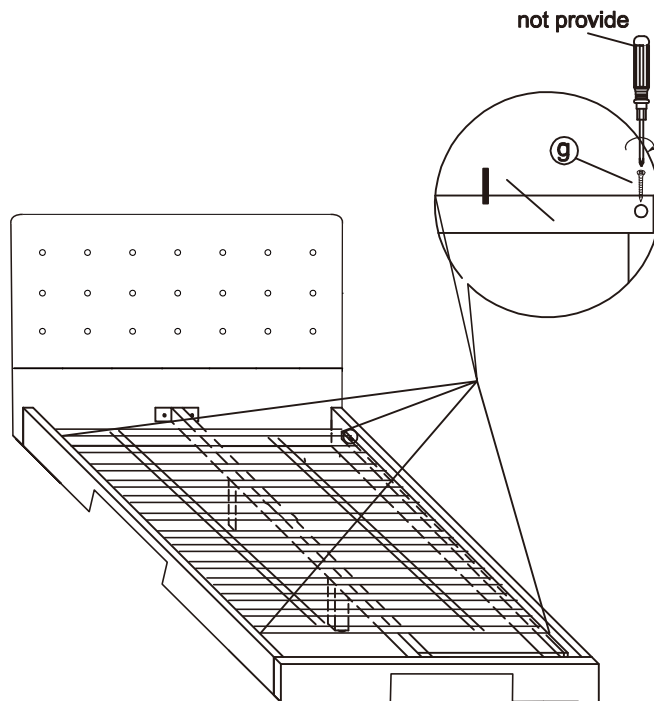

### Step 6/Étape 6

Put the drawer (B, D) under the bed

/Placez les tiroirs (B, D) sous le lit

